

AlumaFeed™

Synergic Aluminum Welding System

MIG Welding System
for Aluminum Welding 

Quick Specs

Heavy Industrial Applications

Boat, ship and yacht building
Recreational vehicles
Trucks and trailer
Sign manufacturers
Emergency vehicles

Processes

Aluminum MIG (GMAW)
Aluminum pulsed MIG (GMAW-P)
Aluminum synergic pulsed MIG

XR-AlumaFeed

Input Power

24 VAC, 50/60 Hz

Wire Feed Speed

50–900 ipm
(1.3–22.9 m/min.)

Net Weight

42.5 lb. (19.2 kg)

AlumaPower 350 MPa and 450 MPa

Input Power

350: Requires 3- or 1-phase power, 208–575 V, 50/60 Hz
450: Requires 3-phase power, 230/460 V, 60 Hz

Rated Output

350: 10–38 V, 5–425 A
450: 10–38 V, 15–600 A

Net Weight

350: 80 lb. (36.3 kg)
450: 122 lb. (55.3 kg)

The XR-AlumaFeed™ and AlumaPower™ 350 MPa or 450 MPa combine for a synergic system that simplifies and improves MIG and pulsed MIG welding applications for aluminum welding.

Ultra portable and versatile.

The slim ergonomic design of the XR-Aluma-Pro torch allows access into the tightest of quarters. Coupled with the XR-AlumaFeed feeder and the AlumaPower 350 MPa or 450 MPa synergic power supply, it has the features for all of your aluminum fabrication needs.

Synergic pulsed welding mode offers the simplicity of single-knob control. The machine will select the correct pulse power based on the wire feed speed (WFS) set by the operator.

Profile Pulse™ Achieve “stacked dime” weld bead appearance without back-stepping. See page 2 for more information.

Parameter and system locks provide three levels of protection to prevent accidental modification of welding parameters or manipulation of setup menu items.



AlumaFeed synergic aluminum welding system with AlumaPower 450 MPa and XR-Aluma-Pro gun shown.

Comes complete with:

- XR-AlumaFeed push-pull wire feeder
- AlumaPower 350 MPa **OR** 450 MPa power source
- XR-Aluma-Pro™ **OR** XR™-Pistol push-pull welding gun
- .035- and 3/64-inch (0.9 and 1.2 mm) contact tips, drive roll and liners for guns
- .035- and 3/64-inch (0.9 and 1.2 mm) drive rolls for wire feeder, 3/64-inch installed

Note: All AlumaFeed systems come set up out of the box to run 3/64-inch (1.2 mm) 5356 wire.

Order weld cables and other accessories separately.

Synchronized, true push-pull wire feed system. Slave/torque motor ensures smooth, consistent feeding and improved arc performance, while reducing the problems normally associated with feeding aluminum.



AlumaFeed synergic aluminum welding system also available with XR-Pistol gun.



Power source/wire feeder are warranted for three years, parts and labor.
Original main power rectifier parts are warranted for five years.
Gun warranted for one year, parts and labor.



Miller Electric Mfg. Co.
An ITW Welding Company
1635 West Spencer Street
P.O. Box 1079
Appleton, WI 54912-1079 USA

Equipment Sales US and Canada
Phone: 866-931-9730
FAX: 800-637-2315
International Phone: 920-735-4554
International FAX: 920-735-4125

MillerWelds.com
    



AlumaFeed™ Synergic Aluminum Welding System Features

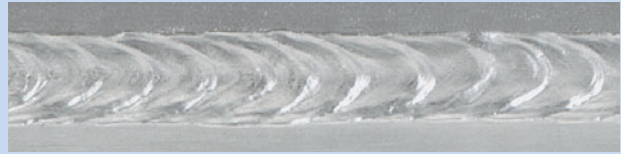

Profile Pulse™ Achieve "stacked dime" weld bead appearance without back-stepping. Profile Pulse frequency can be changed to increase or decrease the spacing between the ripple pattern to achieve the desired weld appearance.

Weld Cross Section



Hot Start Off



Hot Start On

Begin and end welds with ease and confidence. **Hot Start™** eliminates incomplete fusion at the beginning of a weld, a common issue with aluminum welding. **Crater** gradually decreases weld current at the end of a weld to eliminate crater defects. Adjustable preflow and postflow rates ensure that the puddle always has adequate gas coverage.



Flowmeter. Standard integrated flowmeter helps to regulate and maintain proper gas flow rate. Helpful when feeder is located long distances from gas supply. Helps ensure weld quality.



Gun bushing. Improved gun connection uses a bushing that captures the power end of gun to ensure correct alignment to drive rolls and provides exceptional ruggedness and durability.

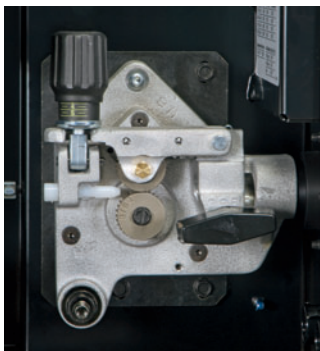

Drive assembly. Improved drive assembly with numeric scale for different wire sizes prevents wire slippage and deformation. Helps improve wire feeding by making sure the proper drive-roll tension is used. Comes factory-installed with 3/64-inch drive rolls.

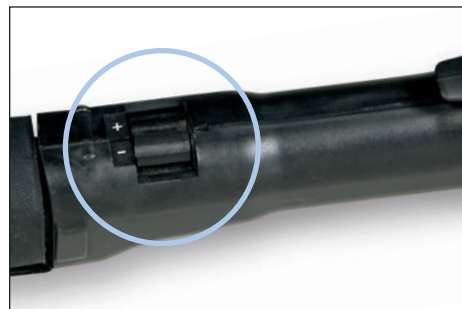

Synergic "one-knob" control. Set the wire feed speed control on the gun and the system handles the rest, greatly simplifying set-up and reducing training time. No need to travel back to the power source to change multiple parameters.

XR-AlumaFeed™ Wire Feeder

Gun calibration allows control box to sync with the welding gun for precise wire feed control that is critical for reducing weld defects and providing flawless synergic operation.

Advanced trigger provides “trigger interlock” capability and the ability to control the amount of time spent in the arc start and arc crater steps.

Bright digital displays are easy to read, and display voltage or arc length and wire feed speed or amperage. Also have indicators for start and crater, setup, schedule select and advanced trigger operations. Two-knob, three-button panel layout makes it simple to change parameters and reduces training time.



Trigger schedule select (SCHD) allows the operator to select the alternative schedule by quickly tapping the gun trigger when not welding. Useful when switching between two welding parameters is needed.

Setup guide on inner panel of feeder has quick tips to get your system up and running quickly. Also provides a good reference that won't get misplaced like an owner's manual.

Rugged steel case holds up in the harshest environments and protects wire from dirt and moisture. Also has a large carrying handle for improved durability.

XR-AlumaFeed Specifications (Subject to change without notice.)

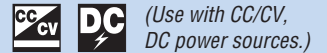

Input Power	Input Welding Circuit Rating	Wire Feed Speed	Wire Type and Diameter Capacity	Maximum Spool Size Capacity	Dimensions	Net Weight
24 VAC, 5 A, 50/60 Hz	400 A at 100% duty cycle System duty cycle is limited to gun rating	50–900 ipm (1.3–22.9 m/min.)	Aluminum .035–.062 in. (0.9–1.6 mm) Solid Wire .035–.045 in. (0.9–1.2 mm) Drive roll kit 268850 required to run 1/16 in. (1.6 mm) wire	12 in. (305 mm)	H: 16 in. (406 mm) W: 9.5 in. (241 mm) D: 21.25 in. (540 mm)	42.5 lb. (19.2 kg)

XR-AlumaFeed Control Panel

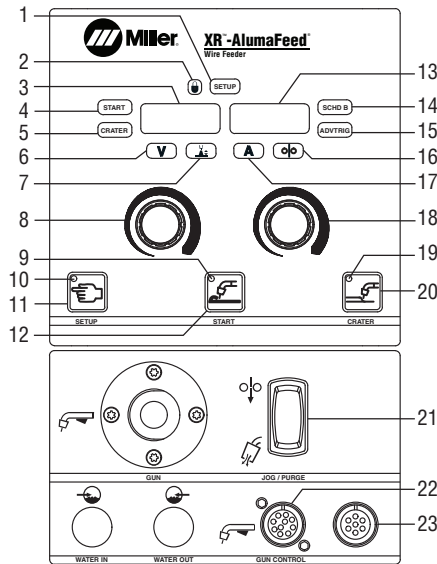

- 1. Setup Menu Indicator
- 2. Lock Indicator
- 3. Left Display
- 4. Start Menu Indicator
- 5. Crater Menu Indicator
- 6. Volts Indicator
- 7. Arc Length Indicator
- 8. Left Adjust Knob
- 9. Start On Indicator
- 10. Setup Indicator
- 11. Setup Button
- 12. Start Button
- 13. Right Display
- 14. Schedule B Indicator
- 15. Advanced Trigger Indicator
- 16. Wire Speed Indicator
- 17. Amps Indicator
- 18. Right Adjust Knob
- 19. Crater On Indicator
- 20. Crater Button
- 21. Jog/Purge Switch
- 22. Gun Connector
- 23. Optional Remote Connector

Power Source Compatibility for XR-AlumaFeed Wire Feeder

Power Source	Pulse Capable	Synergic Pulsed MIG	Profile Pulse Capability	Electronic Inductance/SharpArc®	Compatibility
AlumaPower™ 350 and 450 MPa	Yes (Aluminum only)	Yes (Aluminum only)	Yes	Yes	Optimized
Invision™ 352 and 450 MPa	Yes	Yes	Yes	Yes	Best
XMT® 350 and 450 MPa	Yes	Yes	Yes	Yes	Best
XMT® 350 and 450 CC/CV	Yes (with Optima)	No	No	Yes	Better
XMT® 304 CC/CV	Yes (with Optima)	No	No	Yes	Better
Invision™ 456P	Yes (with Optima)	No	No	Yes	Better
Invision™ 456MP	Yes	No	No	Yes	Better
Invision™ 354P	Yes (with Optima)	No	No	Yes	Better
Invision™ 354MP	Yes	No	No	Yes	Better
Deltaweld® (after KF790532)	No	No	No	No	Good

Note: Power sources not included in this list are not recommended. For specific information, please contact your local Miller distributor.

XR-Aluma-Pro™ Specifications (Subject to change without notice.)



Model	Welding Current Rating	Wire Feed Speed	Wire Diameter Capacity	Dimensions	Net Weight (Gun only)
XR-Aluma-Pro™ (air-cooled)	300 A at 100% duty cycle	70–900 ipm (1.8–23 m/min.) dependent on control box or Millermatic® used	.030–1/16 in. (0.8–1.6 mm) aluminum wire Wire kit 230708 required to run 1/16 in. (1.6 mm) wire	H: 5 in. (127 mm) W: 2.5 in (64 mm) D: 17 in. (432 mm)	2.5 lb. (1.1 kg)
XR-Aluma-Pro™ (water-cooled)	400 A at 100% duty cycle				2.9 lb. (1.3 kg)

XR-Aluma-Pro Parts Breakdown

Air-Cooled XR-Aluma-Pro

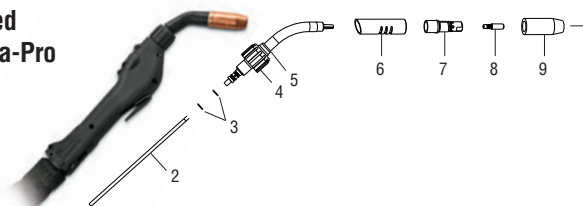

- | | |
|--|---|
| 1. Air-Cooled Assembly
Short Head Tube, 4 in. 231519
Long Head Tube, 6 in. 231518* | 6. Outer Insulating Jacket
Short 227159
Long 229673 |
| 2. Head Tube Liner (see chart below) | 7. Gas Diffuser 229670 |
| 3. Head Tube O-Rings 230969 | 8. FasTip™ Contact Tip (see chart below) |
| 4. Lock Nut 227168 | 9. Nozzle 198855 |
| 5. Insulator Ring Rear 227416 | *Optional |

Water-Cooled XR-Aluma-Pro

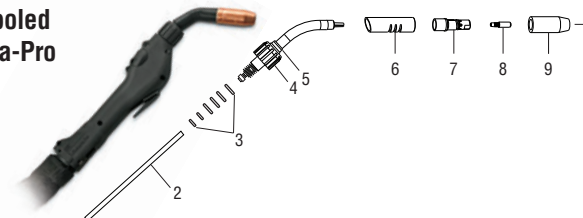

- | | |
|---|--|
| 1. Water-Cooled Assembly
Long Head Tube, 6 in. 231517 | 5. Insulator Ring Rear 227416 |
| 2. Head Tube Liner (see chart below) | 6. Outer Insulating Jacket 230420 |
| 3. Head Tube O-Rings 230970 | 7. Gas Diffuser 229670 |
| 4. Lock Nut 229889 | 8. FasTip™ Contact Tip (see chart below) |
| | 9. Nozzle 199618 |

Important: A wider selection of FasTip™ and Centerfire™ Series consumables are available — see Gooseneck-Style Guns literature M/1. 71.

XR-Aluma-Pro Standard Replacement Consumables (Order from Miller Service Parts.)

Aluminum Wire Size	FasTip Contact Tip (Qty. 25)	Drive Rolls	Idler Rolls	Inlet Guides	Liner for Short Air-Cooled Head Tube 4 in. (102 mm)	Liner for Long Air- or Water-Cooled Head Tube 6 in. (152 mm)	Cable Liners
.030 in. (0.8 mm)	206186 .041 in. ID	227434	227439	227408	227161	229674	229887 15 ft. (4.6 m)
.035 in. (0.9 mm)	206187 .047 in. ID	227434	227439	227408	227161	229674	229891 25 ft. (7.6 m)
.040 in. (1.0 mm)	206188 .053 in. ID	227434	227439	227408	227161	229674	232321 35 ft. (10.6 m)
3/64 in. (1.2 mm)	206189 .061 in. ID	227434	227439	227408	230239	229431	
1/16 in. (1.6 mm)	206191 .071 in. ID	227434	230710	230711	230239	229431	

XR-Aluma-Pro Genuine Miller® Accessories

Leather Cable Cover

234109 15 ft. (4.6 m)

234110 25 ft. (7.6 m)

234111 35 ft. (10.6 m)

Protects gun hose and cable assembly from wear and abrasion. Features full-length hook-and-loop closure for ease of maintenance or replacement.

Short Leather Gun Cover **234416**

Cover is 17 inches (432 mm).

Short Air-Cooled Head Tube Assembly

231519

60-degree/4-inch (102 mm) standard head tube includes liner.

Long Air-Cooled Head Tube Assembly

231518

60-degree/6-inch (152 mm) optional head tube includes liner.

1/16-inch (1.6 mm) Wire Kit **230708**

Specially designed for 1/16-inch wire. Includes idler roll, head tube liner and inlet guide. Required when running 1/16-inch wires. Not included with standard XR-Aluma-Pro gun.

Hardwire Liner Kit for Steel and Stainless

198377 For 15, 25, or 35 ft.

(4.6, 7.6 or 10.6 m) guns

Kit consists of gun head tube liner **233998** listed below and feed cable liner. Recommend using .030–.045 inch mild steel or stainless steel electrode wire.

Note: .052- and 1/16-inch wires not recommended.

Phosphorous Bronze Liner

233999 Long Head Tube (air or water)

233998 Short Head Tube (air only)

For use with hardwire liner kit **198377** above when used in XR-Aluma-Pro gun.

XR™-Pistol Specifications (Subject to change without notice.)



Model	Welding Current Rating	Wire Feed Speed	Wire Diameter Capacity	Dimensions	Net Weight
XR-Pistol (air-cooled)	200 A at 100% duty cycle 250 A at 60% duty cycle	70–875 ipm (1.8–22.2 m/min.)	.030–1/16 in. (0.8–1.6 mm) aluminum wire	H: 7.375 in. (187 mm) W: 1.875 in. (48 mm) D: 10.625 in. (270 mm)	Gun only: 2.2 lb. (1 kg) 15 ft. gun with cable: 13 lb. (5.9 kg) 30 ft. gun with cable: 21 lb. (9.5 kg)
XR-Pistol (water-cooled)	400 A at 100% duty cycle				Gun only: 2.4 lb. (1.1 kg) 15 ft. gun with cable: 14 lb. (6.4 kg) 30 ft. gun with cable: 21.5 lb. (9.8 kg)

XR-Pistol Air-Cooled Parts Breakdown

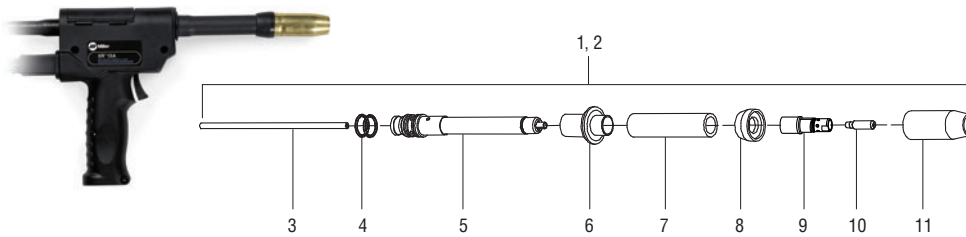

- | | |
|-----------------------------------|------------|
| 1. Air-Cooled Assembly | Kit 231523 |
| 2. Water-Cooled Assembly* | Kit 231524 |
| 3. Head Tube Liner | 212156 |
| 4. O-Ring .614 ID | 134800 |
| 5. Head Tube (Air-cooled) | 221087 |
| Head Tube (Water-cooled)* | 221519 |
| 6. Head Tube Pistol Insulator | 219795 |
| 7. Outer Insulating Jacket | 219794 |
| 8. Nozzle Insulator | 232284 |
| 9. Diffuser | 227749 |
| 10. Contact Tip (see chart below) | |
| 11. Nozzle | 199613 |

*Order water-cooled parts from Miller Service Parts.

Important: A wider selection of FasTip™ and Centerfire™ Series consumables are available — see Pistol-Grip Guns literature M/1.73.

XR-Pistol Standard Replacement Consumables (Air-cooled only.) (Order from Miller Service Parts.)

Aluminum Wire Size	FasTip Contact Tip (Qty. 25)	Drive Rolls	All-Wire Dual Groove Drive Rolls	Head Tube Liner	Cable Liners
.030 in. (0.8 mm)	206186 .041 in. ID	183357	136135	212156	191065 15 or 30 ft. (4.6 or 9 m)
.035 in. (0.9 mm)	206187 .047 in. ID	183357	136135	212156	
.040 in. (1.0 mm)	206188 .053 in. ID	183357	136135	212156	
3/64 in. (1.2 mm)	206189 .061 in. ID	183358	136135	212156	
1/16 in. (1.6 mm)	206191 .071 in. ID	183358	136135	212156	

AlumaPower™ 350/450 MPa Power Source

Auto-Line™ power management technology on 350 model allows for any input voltage hook-up (208–575 V) with no manual linking. Ideal solution for dirty or unreliable input power. (450 model is manual link.)

Fan-On-Demand™ cooling system operates only when needed, reducing noise, energy use and the amount of contaminants pulled through machine.

Large, dual digital meters are easy to view and are presettable to ease setting weld output.

Inverter arc control technology provides greater puddle control for outstanding MIG and pulsed MIG weld performance.

Lightweight, aerospace-grade aluminum case offers protection and the benefit of reduced weight.

Ultra-tough, polycarbonate-blended cover for control panel protects front controls from damage.

Easy setup for MIG and pulsed MIG applications.

Line voltage compensation keeps welding output constant even if input power varies by +/-10 percent. 350 models further expand line voltage compensation to an amazing +37%/-59 percent when operating on 460 V.

SharpArc® controls the arc in pulsed MIG mode and gives control over the arc cone shape, puddle fluidity, and bead profile. If a gas is used other than Ar 100% (argon), SharpArc can be adjusted to help customize your arc to the gas being used.

Weld Cross Section

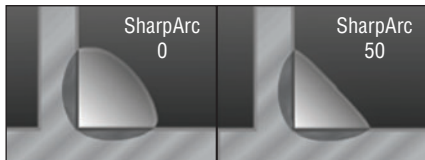

Additional Features

Power factor of .95 enables smaller fuses/breakers and primary wiring. Primary amperage draw at rated output is 25-percent less than the competition.

Built-in synergic or standard pulsed MIG capabilities. See the list below of built-in pulsed MIG (GMAW-P) aluminum programs.

Wire Type	Gas Type
.035 AL 4043	Ar 100% (argon)
.040 AL 4043	Ar 100% (argon)
3/64 AL 4043	Ar 100% (argon)
1/16 AL 4043	Ar 100% (argon)
.035 AL 5356	Ar 100% (argon)
.040 AL 5356	Ar 100% (argon)
3/64 AL 5356	Ar 100% (argon)
1/16 AL 5356	Ar 100% (argon)

AlumaPower Specifications (Subject to change without notice.)



Model	Input Power	Amp/Volt Ranges	Rated Output	Amps Input at Rated Load Output, 60 Hz					KVA	KW	Max. Open-Circuit Voltage	Dimensions	Net Weight
				208 V	230 V	400 V	460 V	575 V					
AlumaPower 350 MPa	Three-phase	CC mode: 5–425 A CV mode: 10–38 V	350 A at 34 VDC, 60% duty cycle	40.4	36.1	20.6	17.8	14.1	14.2	13.6	75 VDC	H: 17 in. (432 mm) W: 12.5 in. (318 mm) D: 24 in. (610 mm)	80 lb. (36.3 kg)
	Single-phase	CC mode: 5–425 A CV mode: 10–38 V	300 A at 32 VDC, 60% duty cycle	60.8	54.6	29.7	24.5	19.9	11.7	11.2			
AlumaPower 450 MPa	Three-phase	CC mode: 15–600 A CV mode: 10–38 V	450 A at 36.5 VDC, 100% duty cycle	—	49.4	—	27.2	23.6	21.6 (23.5 on 575 V)	18.3	90 VDC	H: 17.25 in. (438 mm) W: 14.5 in. (368 mm) D: 27.125 in. (689 mm)	122 lb. (55.3 kg)

Certified by Canadian Standards Association to both the Canadian and U.S. Standards.

AlumaPower Control Panel

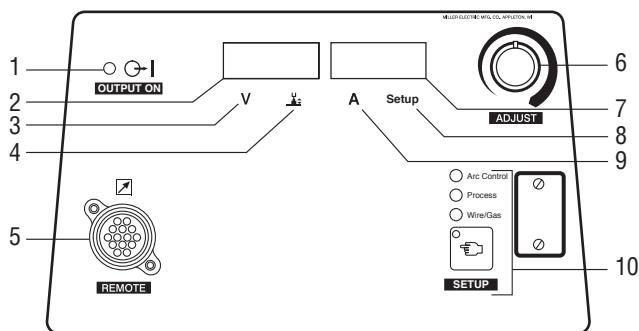

1. Output ON Indicator Light
2. Left Display
3. Voltage Indicator
4. Arc Length Indicator
5. Wire Feeder Receptacle
6. Adjustment Control
7. Right Display
8. Setup Indicator
9. Amperage Indicator
10. Setup Indicator Lights
 - Arc Control Indicator
 - Process Indicator
 - Wire/Gas Type Indicator
 - Setup Button

MPa M (MIG), P (Pulse), a (Advanced Arc Control)

Advanced arc control enables an improved pulse welding arc. The operator has more control over puddle and bead characteristics using SharpArc. In addition, the unit provides a more robust and stable arc at very low arc length, reducing heat input, and providing the ability to weld on a wider range of material thickness.

What are some benefits of synergic pulsed MIG?

1. Easier to set up
2. No more changing wire speed, and then having to go back to the power source to reset the welding output.

Performance Data

AlumaPower 350 MPa Duty Cycle Chart

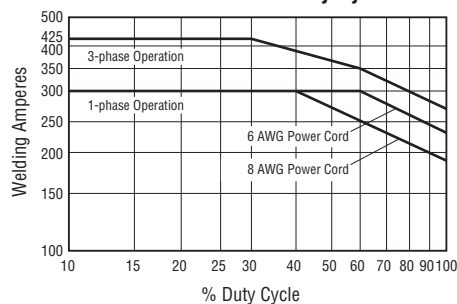

AlumaPower 450 MPa Duty Cycle Chart

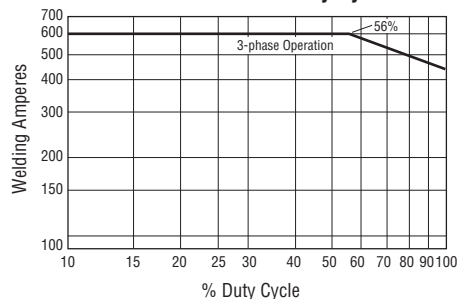

AlumaPower™ Genuine Miller® Accessories



Industrial MIG 4/0 Kit with Dinse Connectors 300405

For AlumaPower 350 MPa power source. Includes flowmeter regulator with 10-foot (3 m) gas hose, 10-foot (3 m) 4/0 feeder weld cable with Dinse-style connector on one end and a lug on the other, 15-foot (4.6 m) work cable with Dinse-style connector on one end and 600-amp C-clamp on the other.

Industrial MIG 4/0 Kit 300390

For AlumaPower 450 MPa power source. Includes the same as the kit above, except weld and work cables have lugs instead of Dinse-style connectors.

Remote Control Extension Kits

- 242205025** 25 ft. (7.6 m)
 - 242205050** 50 ft. (15 m)
 - 242205080** 80 ft. (24.3 m)
- Fully loaded 14-pin extension cords for remote controls or 24 V and 115 V feeders.

Cable Connectors and Adapters

Note: AlumaPower 350 power sources are equipped with Dinse-style connectors for secondary connections.



Dinse/Tweco® Adapter 042465

Dinse/Cam-Lok Adapter 042466

One-piece adapter with Dinse-style male plug (to power source) on one end and female receptacle (Tweco or Cam-Lok for weld cable connection) on other end.

Dinse-Style Connector Kit

- 042418** Accepts #4 to #1/0 AWG cable size.
 - 042533** Accepts #1/0 to #2/0 AWG cable size.
- Kit includes one male Dinse-style plug which attaches to the work and/or weld cables and plugs into the Dinse-style receptacles on the power source.

Extension Kit for Dinse-Style Cable Connectors 042419

Accepts #4 to #1/0 AWG cable size. Used to adapt or extend weld and/or work cables. Kit includes one male Dinse-style plug and one in-line female Dinse-style receptacle.

AlumaFeed™ System Genuine Miller® Accessories

Remote Connector Kit 300898 Field Useful when pairing XR-AlumaFeed with an automated system. Allows remote trigger function, or remote voltage or arc length when used with XR-Aluma-Pro™ or XR™-Pistol guns and remote. See XR-Aluma-Pro literature M/1.73 or XR-Pistol literature M/1.71 for gun stock numbers.



Universal Carrying Cart and Cylinder Rack 042934

Holds power source, and gas cylinder up to 56 inches (142.2 cm) high measuring 6 to 9 inches (15.2 to 22.8 cm) in diameter.



Coolmate™ 4 042288 115 V

For use with water-cooled torches rated up to 600 amps. Tough molded polyethylene case with carrying handle.



MIGRunner™ Cart 195445

Small footprint and easily maneuverable, with cylinder rack low enough that you do not have to lift bottles.

Coolant Systems

For more information see literature AY/7.2.



Coolmate™ 3 043007 115 V
043008 230 V

For use with water-cooled torches rated up to 600 amps. Unique paddle-wheel indicator, external filter and easy-fill spout.

Coolant 043809

Sold in cases of four one-gallon recyclable plastic bottles. Miller coolants contain a base of ethylene glycol and deionized water to protect against freezing to -37 degrees Fahrenheit (-38° C) or boiling to 227 degrees Fahrenheit (108° C). Also contains a compound that resists algae growth.

AlumaFeed MIGRunner™



AlumaFeed 350 MIGRunner with 25-foot (7.6 m) air-cooled XR-Aluma-Pro gun shown.

- 951151** AlumaFeed 350 with 25 ft. (7.6 m) air-cooled XR-Aluma-Pro gun
- 951555** AlumaFeed 350 with 25 ft. (7.6 m) water-cooled XR-Aluma-Pro gun
- 951153** AlumaFeed 350 with 30 ft. (9 m) air-cooled XR-Pistol gun
- 951556** AlumaFeed 350 with 30 ft. (9 m) water-cooled XR-Pistol gun
- 951459** AlumaFeed 450 with 25 ft. (7.6 m) air-cooled XR-Aluma-Pro gun
- 951559** AlumaFeed 450 with 25 ft. (7.6 m) water-cooled XR-Aluma-Pro gun

Packages include:

- AlumaPower 350 or 450 MPa power source (350 MPa water-cooled packages and all 450 MPa packages have 115 V auxiliary power)
- XR-AlumaFeed wire feeder
- Air- or water-cooled XR-Aluma-Pro (gooseneck-style) or XR-Pistol (pistol-grip-style) push-pull gun
- MIGRunner cart
- Industrial MIG 4/0 MIG kit with Dinse connectors
- Gun and feeder drive rolls and consumables to run .035–3/64 inch (0.9–1.2 mm) wire (1/16-inch consumables not included, order separately)
- Coolmate 3 and coolant included with water-cooled packages

Typical Installation

Note: Cords and cables are supplied unless noted otherwise on drawing below. Refer to Owner's Manual for complete installation instructions.

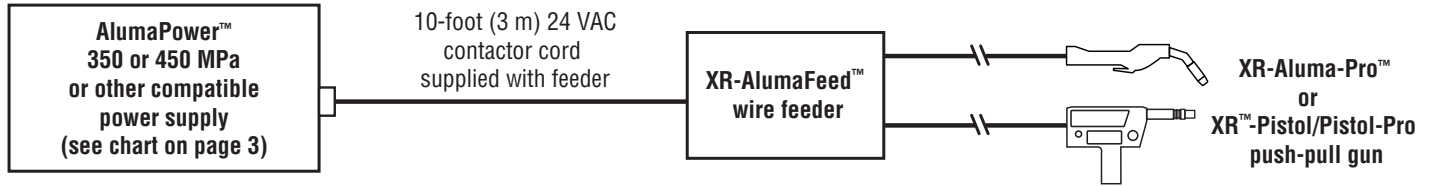

Ordering Information

Power Source and Options	Stock No.	Description	Qty.	Price
AlumaFeed™ Synergic Aluminum Welding Systems (Includes AlumaPower™ 350 MPa or 450 MPa power source, XR-AlumaFeed™ wire feeder, gooseneck or pistol-grip push-pull gun (air- or water-cooled), plus gun and feeder drive rolls and consumables to run .035–3/64 inch (0.9–1.2 mm) wire. 1/16-inch drive rolls and consumables NOT included — order separately below. Coolmate™ 3 and coolant included with water-cooled packages. 350 MPa water-cooled packages and all 450 MPa packages have 115 V auxiliary power.)	951162	350 MPa with 10-foot (3 m) air-cooled XR-Aluma-Pro™ gun		
	951158	350 MPa with 15-foot (4.6 m) air-cooled XR-Aluma-Pro™ gun		
	951147	350 MPa with 25-foot (7.6 m) air-cooled XR-Aluma-Pro™ gun		
	951160	350 MPa with 35-foot (10.7 m) air-cooled XR-Aluma-Pro™ gun		
	951550	350 MPa with 15-foot (4.6 m) water-cooled XR-Aluma-Pro™ gun		
	951551	350 MPa with 25-foot (7.6 m) water-cooled XR-Aluma-Pro™ gun		
	951552	350 MPa with 35-foot (10.7 m) water-cooled XR-Aluma-Pro™ gun		
	951163	350 MPa with 15-foot (4.6 m) air-cooled XR-Pistol gun		
	951149	350 MPa with 30-foot (9 m) air-cooled XR-Pistol gun		
	951553	350 MPa with 15-foot (4.6 m) water-cooled XR-Pistol gun		
951554	350 MPa with 30-foot (9 m) water-cooled XR-Pistol gun			
	951460	450 MPa with 25-foot (7.6 m) air-cooled XR-Aluma-Pro™ gun		
	951557	450 MPa with 25-foot (7.6 m) water-cooled XR-Aluma-Pro™ gun		
AlumaFeed™ MIGRunner™ Packages (Includes the same as above plus MIGRunner cart and industrial MIG 4/0 kit with Dinse-style connectors. 350 MPa water-cooled packages and all 450 MPa packages have 115 V auxiliary power.)	951151	350 MPa with 25-foot (7.6 m) air-cooled XR-Aluma-Pro™ gun		
	951555	350 MPa with 25-foot (7.6 m) water-cooled XR-Aluma-Pro™ gun		
	951153	350 MPa with 30-foot (9 m) air-cooled XR-Pistol gun		
	951556	350 MPa with 30-foot (9 m) water-cooled XR-Pistol gun		
	951459	450 MPa with 25-foot (7.6 m) air-cooled XR-Aluma-Pro™ gun		
951559	450 MPa with 25-foot (7.6 m) water-cooled XR-Aluma-Pro™ gun			
AlumaPower™ 350 MPa Power Source	907420	Power source only. 208–575 V with Auto-Line™		
	907420001	Power source only. 208–575 V with Auto-Line™ and auxiliary power		
AlumaPower™ 450 MPa Power Source	907483	Power source only. 230/460 V with auxiliary power		
	907484	Power source only. 575 V with auxiliary power		
XR-AlumaFeed™ Wire Feeder	300509	Feeder only. Full synergic operation when used with MPa power sources only. Other Miller 14-pin power sources may be used, but feature operation may be limited. Call your Miller distributor for more information.		
XR-AlumaFeed™ Wire Feeder with Remote Connector	300509001			
Gun Accessories				
XR-Aluma-Pro™ 1/16-inch (1.6 mm) Wire Kit	230708	Required with 1/16-inch drive roll kit below to run 1/16-inch wire		
Replacement Cable Covers		See page 4		
Tube Assemblies and Liners		See page 4		
Feeder and Power Supply Accessories				
XR-AlumaFeed™ 1/16-inch (1.6 mm) Drive Roll Kit	268850	Required with 1/16-inch wire kit above to run 1/16-inch wire <i>Order from Miller Service Parts</i>		
Industrial MIG 4/0 Kit with Dinse Connectors	300405			
Remote Control Extension Kits		See page 7		
Cable Connectors and Adapters		See page 7		
System Accessories				
Remote Connector Kit	300898	Field. For AlumaFeed wire feeder		
MIGRunner™ Cart	195445			
Universal Carrying Cart and Cylinder Rack	042934			
Coolant Systems		See page 7. See literature AY/7.2		

Date:

Total Quoted Price:

Distributed by:

